

Article number: 54301310

Description: LDK Rod end PHS 10

Measures

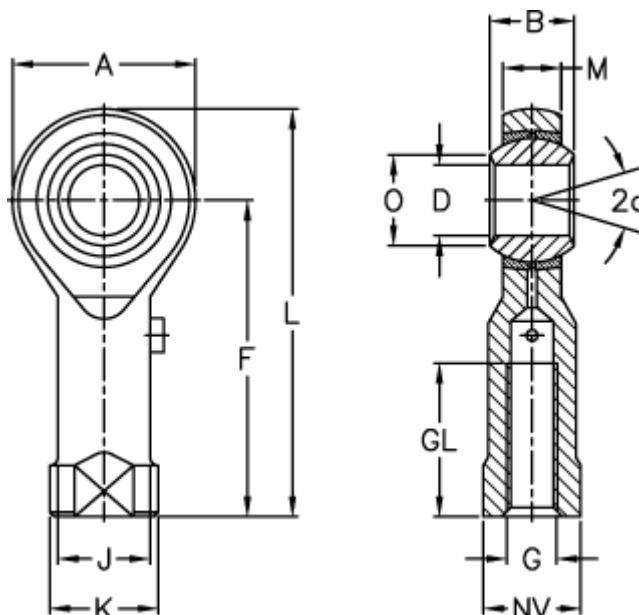

A	= 26	J	= 15.0
a (degrees)	= 13	K	= 19
B	= 14	L	= 56
D	= 10	M	= 10.50
Dynamic load C (kN)	= 7.5	NV	= 17
F	= 43	O	= 12.90
g	= M10	Static load C0 (kN)	= 19.0
GL	= 21	Weight (g)	= 72.0